

LC8-120/277

Lighting Control Panel

UNIT DESCRIPTION

The LC8 Lighting Control Panel is an easy to use lighting controller intended for applications where automated lighting control is required. Lighting control can be configured to respond to scheduling, photocell input, astronomic input, switch input and/or combinations of these. The LC8 is suitable for interior or exterior lighting and can be configured with either single pole single throw relays or double pole single throw relays for multi pole circuits. Configuration changes are easily made through the integrated touch screen that is always accessible through the panel cover.

SPECIFICATIONS

Power input	120/277 VAC; 50/60 Hz
Accessory power	500 mA at 24 VDC
Switch inputs with screw terminals;	
Used with 3-wire momentary, 2-wire momentary or maintained with pilot light output	
Relay grouping	
Configurable to switches through touchscreen user interface	
Panel weight	8.1 lbs. (without relays)
Relays	Modular; dual 1-pole or single 2-pole
LCDP-1 relay ratings	
Ballast/LED Driver	20 A @ 208V
Ballast/LED Driver	20 A @ 240V/480V (2 Phase)
Motor	1 HP @ 208V/240V
Short Circuit Current Rating	14kA AIC @ 277 VAC
LCSP-2 relay ratings	
Incandescent	20 A @ 120V/277V
Ballast/LED Driver	20 A @ 120V/277V
Motor	1/2 HP @ 120V
Short Circuit Current Rating	14kA AIC @ 277 VAC
Relay weight	LCDP-1: 0.49 lbs., LCSP-2: 0.37 lbs.
Operating conditions	For indoor use only
	32-122°F (0-50°C); 5-95% RH noncondensing
UL and CUL listed	

TABLE OF CONTENTS

Quick Setup.....	3
Interior Lighting.....	3
Exterior Lighting.....	6
Installation and Setup.....	10
Installing the Panel.....	10
Wiring SPST Loads.....	11
Wiring DPST Loads.....	12
Connecting Low Voltage Switches to the LC8.....	12
Connecting Occupancy Sensors and Photocells.....	13
Connecting an EM24-D Exterior Photocell to the LC8.....	13
Operation Guide.....	14
Theory of Operation.....	14
Icon Definitions.....	14
Getting Started.....	15
Relays Override.....	16
Setup Menus.....	17
Setting Time and Date.....	17
Daylight Saving Time.....	18
Assigning Relays to an Input.....	19
Assigning Relays to Channels.....	20
Assigning Schedules to Channels.....	21
Schedules.....	21
Schedule ON/OFF.....	21
Manual ON/Schedule OFF.....	23
Astronomic & Schedule ON/OFF.....	24
Photocell & Schedule ON/OFF.....	25
AS-100 Auto ON/OFF.....	26
AS-100 Manual ON/Auto OFF.....	27
Schedule Day Spanning.....	27
Setting up a Holiday Schedule.....	27
Setting a Location for the Astronomic Feature.....	29
Sound Options.....	30
Returning the LC8 Panel to Factory Default Settings.....	30
Troubleshooting.....	31
Lighting Control Panel Circuit & Program Documentation Form.....	32

QUICK SETUP

The LC8 is designed to allow very flexible automated lighting control yet can be set up to do basic automatic control functions very simply. It is assumed that your unit is installed and wired before using this Quick Setup. **The steps for basic control are as follows:**

Interior Lighting

The following example provides quick setup instructions for assigning interior lighting to a schedule. The basic steps are:

1. Set Time and Date
2. Assign Relays to a Channel
3. Set a Schedule
4. Assign Channel to your Schedule

Step 1: Set Time and Date

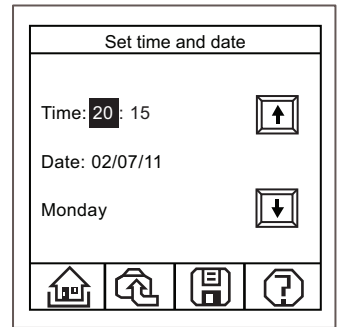
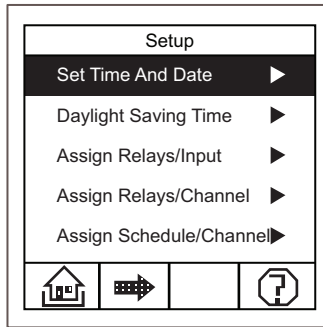
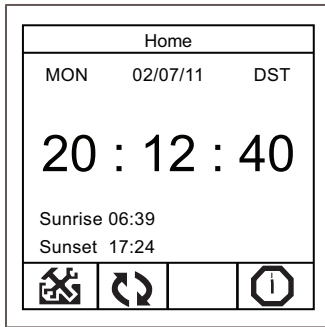

Select Setup  from Home menu

Touch Set Time and Date

Touch Hour to highlight. Use up and down arrows to adjust time. Repeat for setting minutes and date.

Select Save 

Step 2: Assign Relays to a Channel

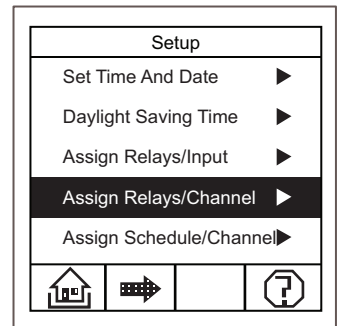
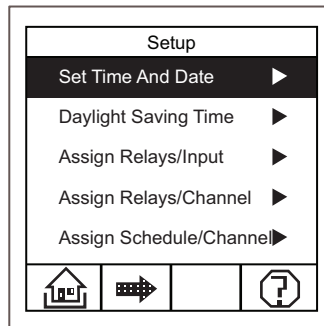
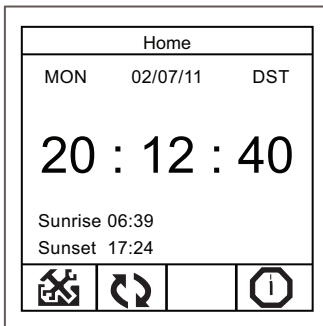

Select Setup  from Home menu

The Setup menu displays

Touch Assign Relays/Channels to highlight. Touch again to enter relay assignment menu

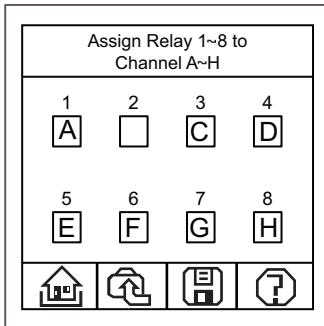

- Select relay number to highlight
- Touch relay number again to select Channel A
- Repeat above for all desired relays

- Select Save 

Note: In the example only relay 1 controls interior lighting and has been assigned to Channel A. Your setup may require more than one relay to be assigned to Channel A.

Step 3: Set a Schedule

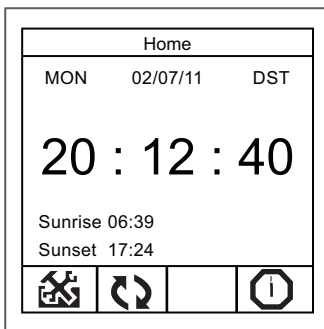

Select Setup  from Home menu

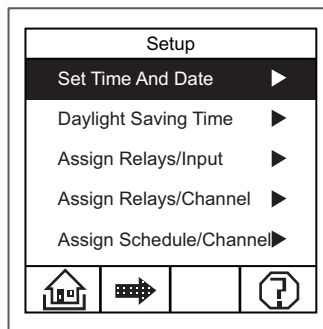

Select Next 

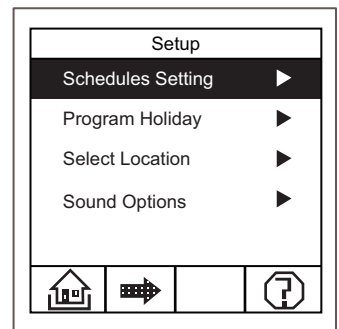

Touch Schedules Setting to display Schedule # setup menu

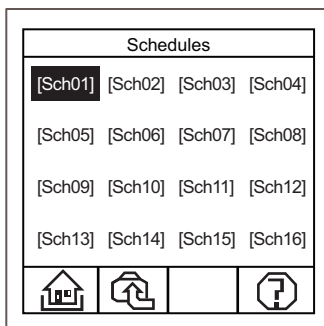

Select [Sch01]. Touch again

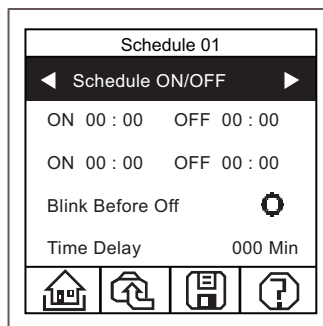

Ensure "Schedule ON/OFF" is highlighted.

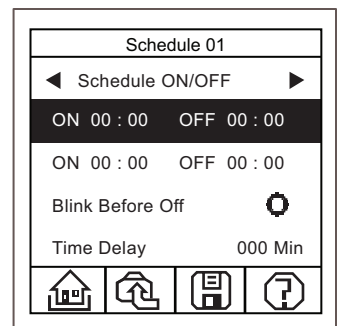

Touch the first ON/OFF setting to highlight. Touch again to display Schedule Time screen.

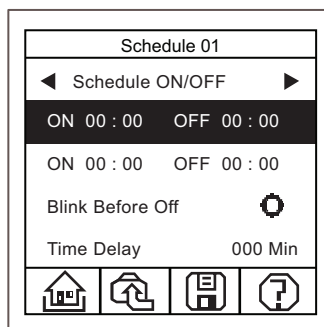
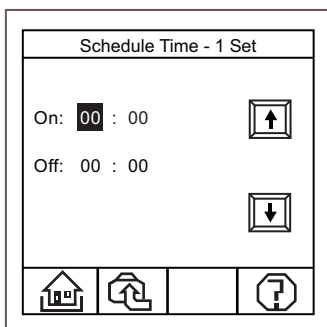

Touch hours (and minutes if desired) to highlight. Use up and down arrows to select times. Select

Select Save  to save settings



Step 4: Assign Channel to your Schedule

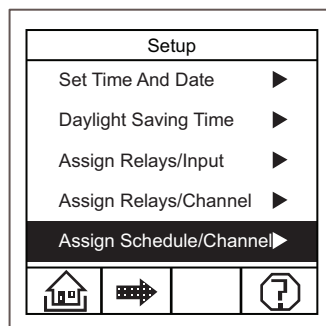
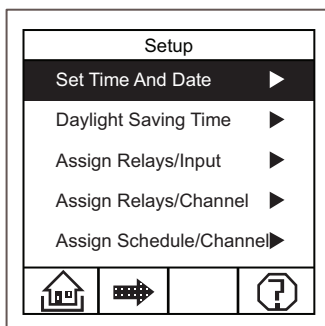
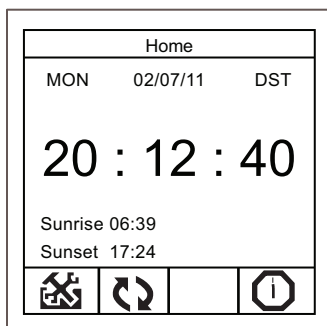

Select Setup  from Home menu

Setup menu displays

Select Assign Schedule/Channel. Touch again

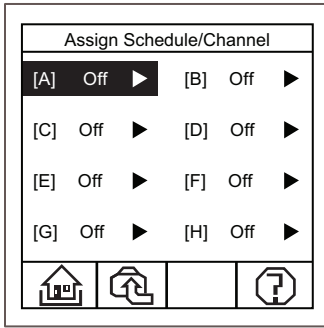

The Assign Schedule/Channel menu displays. Select Channel A

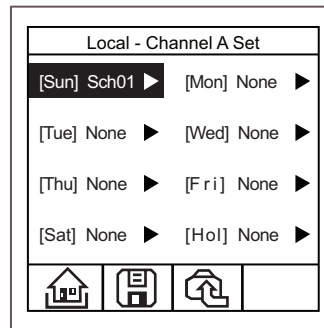

Enter Sch01 to each day of the week desired. Select Save



Result: Interior lighting will turn ON at the scheduled ON time and turn OFF at the scheduled OFF time.

Exterior Lighting

The following example provides basic instructions for configuring exterior lighting to respond to astronomic inputs. The basic steps are:

1. Set Time and Date (unless previously set up)
2. Enter Geographic Location
3. Assign Relays to a Channel
4. Set a Schedule
5. Assign Channel to your Schedule

Step 1: Set Time and Date

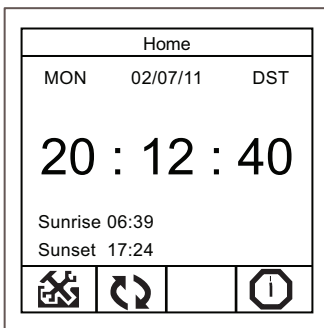

Select Setup  from Home menu

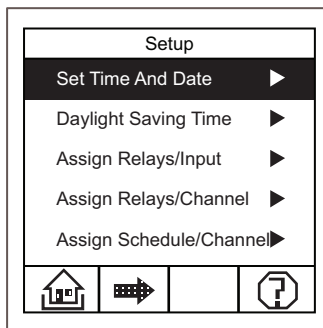

Touch Set Time and Date

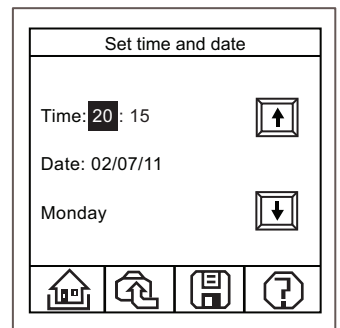

Touch Hour to highlight. Use up and down arrows to adjust time. Repeat for setting minutes and date.

Select Save 

Step 2: Enter Geographic Location

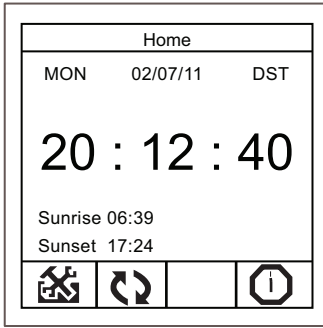

Select Setup  from Home menu

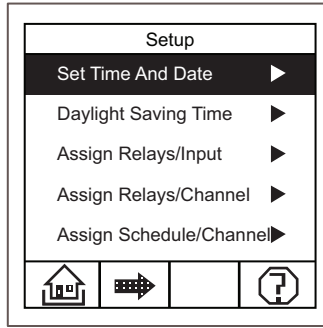

Select Next 

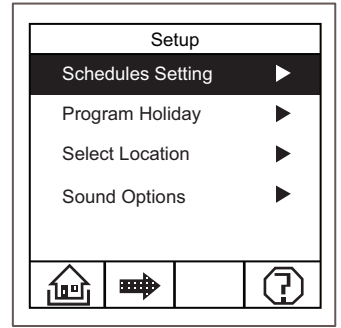

Schedules Setting displays

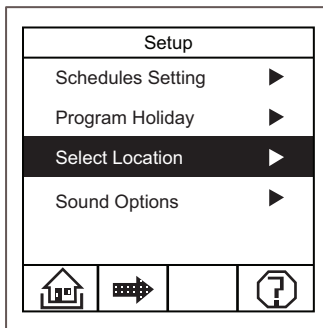

Touch Select Location. Touch again for Location Set

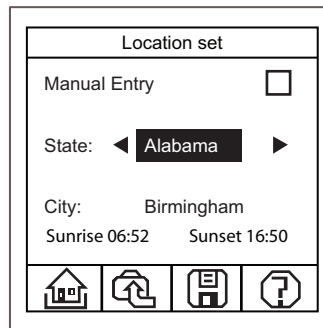

Scroll through entries to select state. Scroll through entries to select city.

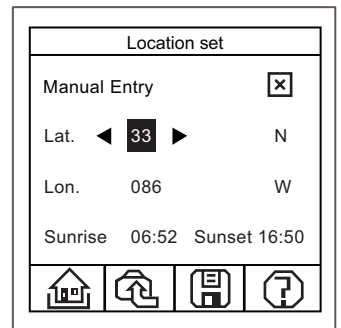

Select Manual Entry. Enter Lat. and Lon. if your location is not in lists.

Select Save 

Select Save 

Step 3: Assign Relays to a Channel

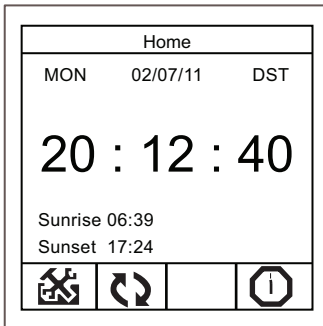

Select Setup  from Home menu

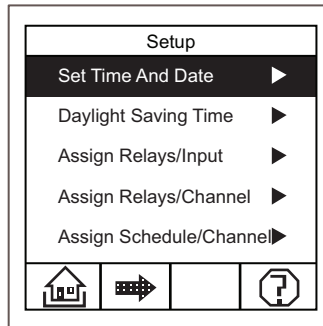

Setup menu displays

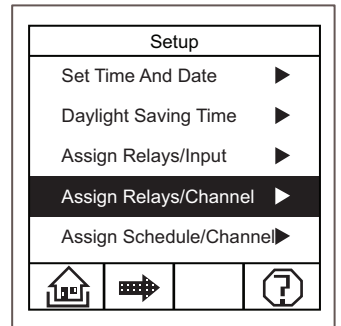

Touch Assign Relays/Channels to highlight. Touch again to enter relay assignment menu

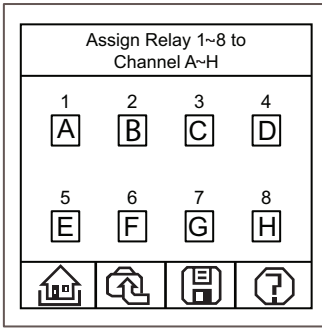

- Select relay # to highlight
- Touch relay number again to select Channel B
- Repeat above for all desired relays

- Select Save 

Step 4: Set a Schedule

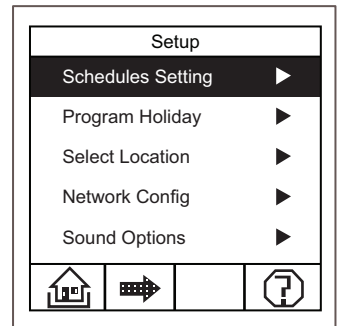
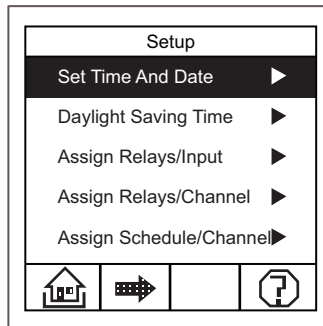
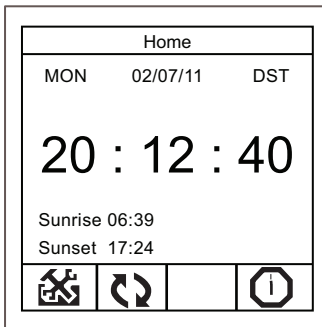

Select Setup  from Home menu

Select Next 

Touch Schedules Setting to display Schedule# setup screen

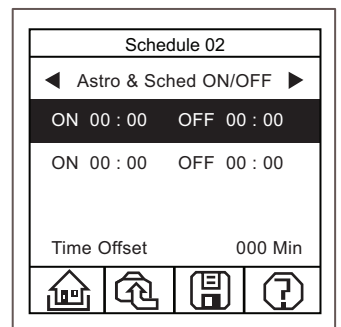
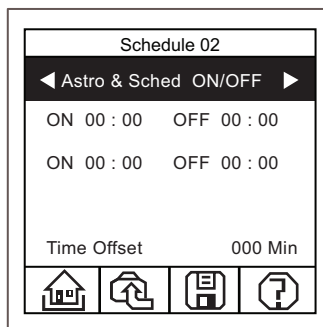
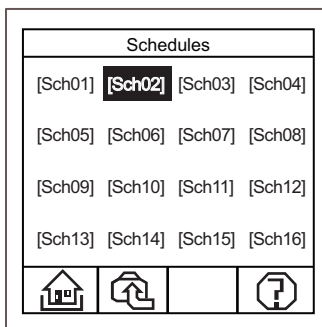

Select [Sch02]. Touch again

Ensure "Astro & Sched ON/OFF" is highlighted

Touch the first ON/OFF setting to highlight.

Step 5: Assign Channel to your Schedule

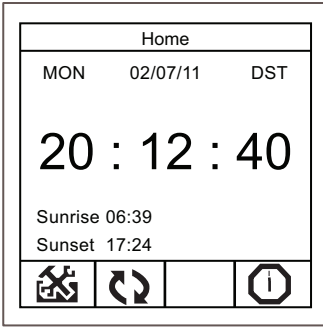

Select Setup  from Home menu

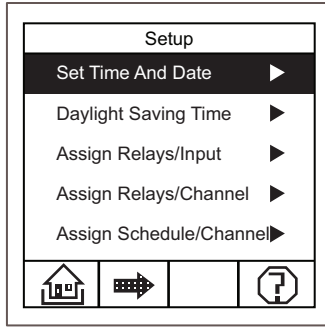

Setup menu displays

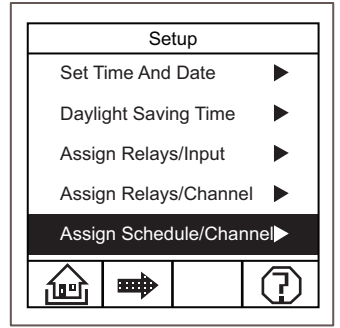

Touch Assign Schedule/Channel. Touch again

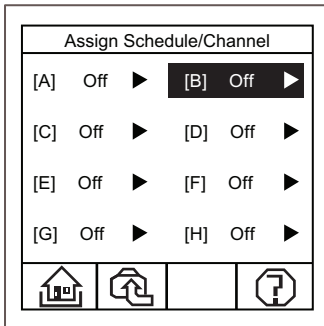

The Assign Schedule/Channel menu displays. Select Channel B

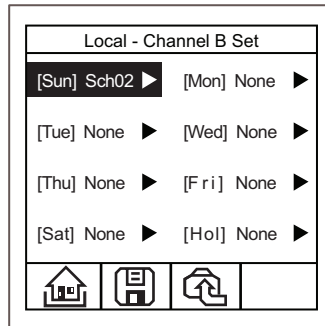

Enter Sch02 to each day of the week desired. Select

Save 

Result: The exterior lighting will turn ON at sunset and turn OFF at sunrise as well as turn ON and OFF according to your schedule.

Note: The above will provide basic lighting control. More complex setups of operation can be achieved through the use of additional schedules and/or accessories such as low voltage wall switches, photocells, or occupancy sensors.

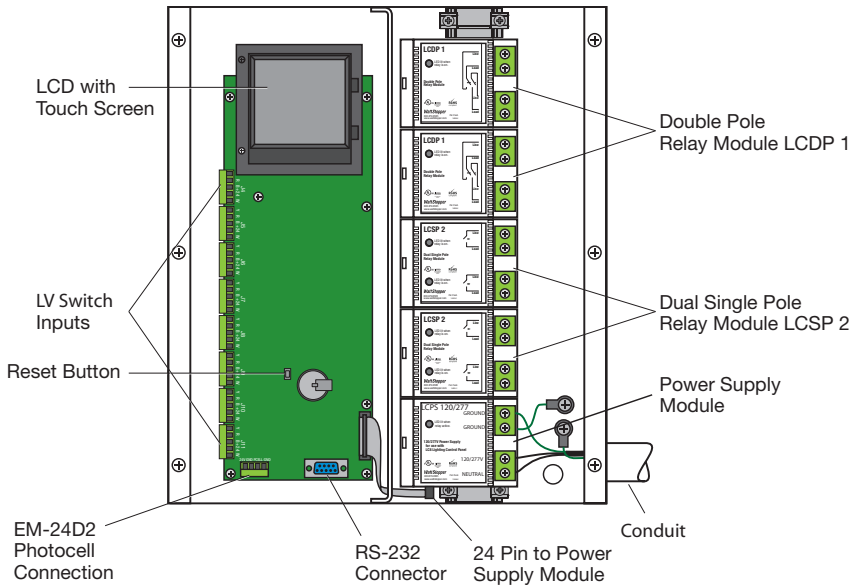

Fig.1: LC8 Components

Installing the Panel

The LC8-120/277 enclosure is designed for surface wall mounting. Attach the enclosure to the wall using hardware appropriate for the wall type and material (not included).

The relays for the LC8 are modular and may have shipped separately from the enclosure. The relay modules are designed for DIN rail mounting. To install the relay modules:

1. Place the module over the DIN rail with the terminal blocks to the right.
2. First, hook the terminal side of the module DIN rail track onto the DIN rail.
3. Then, lower the module and press down until the opposite side of the module clicks to the DIN rail.
4. After the module is attached to the DIN rail, slide the module down the DIN rail until it makes contact with the power supply module.
5. Carefully push the relay module against the power supply module until the multi-pin connector on the relay module fully mates with the matching connector on the power supply module.
6. Repeat this process for all relay modules that are to be installed in the enclosure.
7. When properly installed, there should be approximately 1/16 inch space between each module.
8. Connect the hot feed wire (120 or 277 volts) to the "L" terminal block on the power supply module.
9. Connect the neutral feed wire to the "N" terminal block on the power supply module.
10. Connect the building source supply earth ground wire to earthing ground post. Use the other grounding post to bond power supply module to earth ground.

CAUTION - This unit contains two earthing posts for grounding. Only one dedicated post shall be used for the building source supply ground and is not to be used or shared with any other conductors. The other post can be used for earth bonding of internal components.

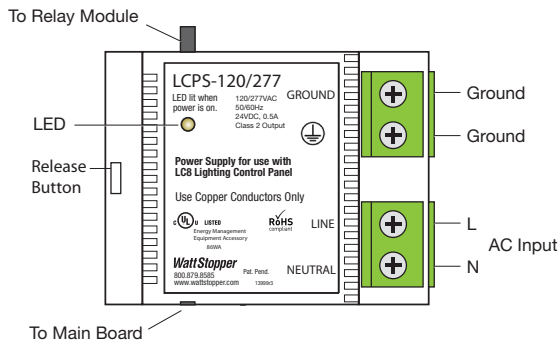

Fig. 2: Power Supply

Energize the feed circuit and note the following conditions:

1. The touch screen display back light will illuminate for a short time.
2. The green LED on the power supply module will illuminate and remain lit.
3. Three red LEDs on the main PC board will illuminate and remain lit.

If any of the above conditions do not occur, refer to the troubleshooting section, otherwise de-energize the feed circuit and continue with the installation.

Wiring SPST Loads

1. Connect each load to the Load terminal on a relay module.
2. Connect the Line terminal for each relay to an appropriate source of power to control the load.
3. Note that the LCSP-2 relay module contains two single pole relays that are independently controlled by the panel. Thus, each LCSP-2 has two Input/Output terminal blocks.

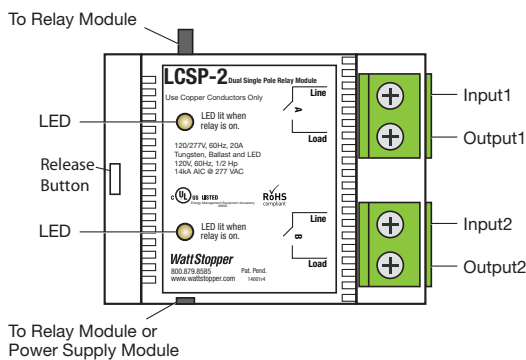

Fig. 3: Relay for SPST Loads

Wiring DPST Loads

1. Connect the load wires to the Output 1 and Output 2 terminal blocks on the LCDP-1 double pole relay module.
2. Connect the double pole circuit to be controlled to the Input 1 and Input 2 terminal blocks.
3. Note that the LCDP-1 relay module contains one double pole relay. Thus, all connections to each LCDP-1 relay module are for the same load.

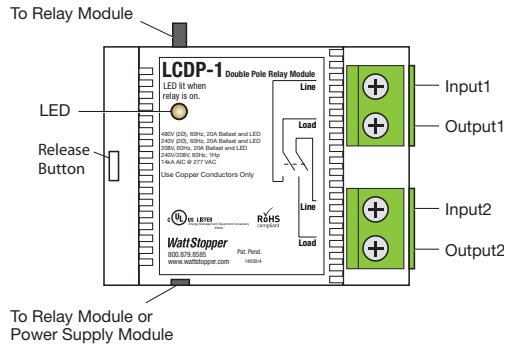
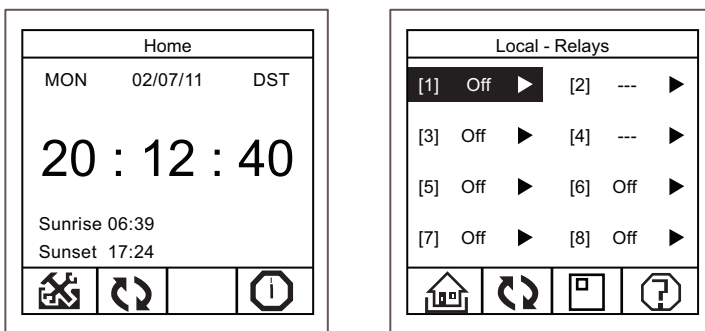

Fig. 4: Relay for DPST Loads

1. Note that the load neutral wires are not connected to the relay modules.
2. Check all load wires for shorts prior to energizing the panel power supply feed or the load feed breakers.
3. Energize the LC8 panel power supply and again note the conditions indicated previously.
4. Touch the <Rotate> icon on the Home page of LCD screen until the Relays screen is displayed.



5. Touch each relay to toggle the relay on and off.
6. Confirm that all of the relays switch and that the loads turn on and off.

Connecting Low Voltage Switches to the LC8

The LC8 will operate with a variety of low voltage switch types including 2 wire momentary, 3 wire momentary, or maintained contact. Switches may be connected to the input terminal blocks 1- 8 and configured to control relays or channels. Connect switches per the following diagrams:

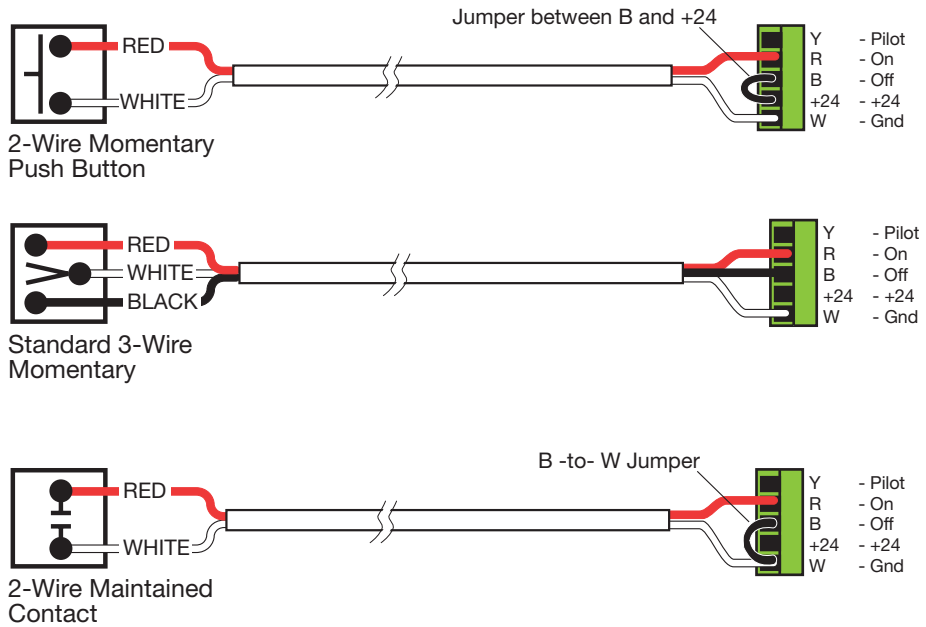

Fig.5: Low Voltage Switches

Connecting Occupancy Sensors and Photocells

Any WattStopper low voltage occupancy sensor that is intended to work with a power pack can be used as an input to the LC8 to control relays. Connect the occupancy sensor per the following diagram:

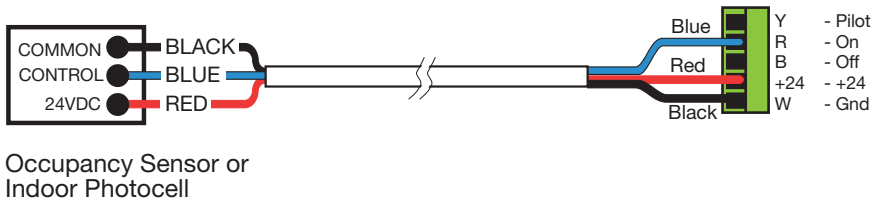

Fig.6: Connecting Occupancy Sensors

Connecting an EM24-D Exterior Photocell to the LC8

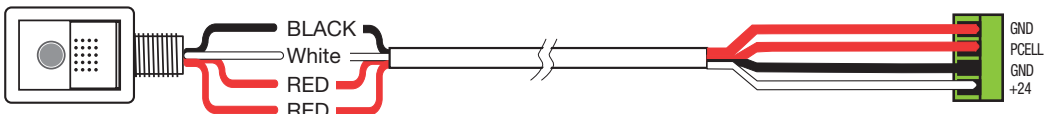

Fig 7: Connecting an EM24-D

OPERATION GUIDE

Theory of Operation

The LC8 lighting control panel is designed to automatically control interior or exterior lighting based on a weekly schedule, astronomic time calculation or input from an accessory photocell. Automatic operation can be augmented or overridden through the use of accessory low voltage wall switches. Automatic operation is conveniently user defined by selecting an operating mode scenario that will automatically combine the clock, astronomic and photocell operations to produce the desired sequence of operation for each day of the week.

The LC8 supports the control of both single pole (120 or 277 volts) and double pole lighting circuits (240, 208, or 480 volts) through the selection of either SPST or DPST relay modules. Modules are available as either a single double pole relay or two independent single pole relays. A maximum of 4 relay modules can be installed in the LC8 panel for a total of 8 circuits of control. Input power to the LC8 panel can be supplied at either 120 or 277 volts.

All user interface with the LC8 is through the illuminated touch screen. There are no pushbuttons or other controls provided except for a reset button located above the battery inside the enclosure.

Icon Definitions

The following is a list of all icons and their functions.



Return to the Home screen with <Home> icon.



Rotate through Input, Relay and Channel screens with <Rotate> icon.



Enter the setup mode with <Setup> icon.



Choose a panel with <Panel Select> icon.



Display Help with <Help> icon.



Save settings with <Save> icon.



Go back with <Back> icon.



Go to the next screen with <Next> icon.



Go to Holiday set range screen with <Range> icon.



Get hardware, firmware versions, and model with <Information> icon.

Getting Started

Upon initial start up, the Logo screen is displayed:



Touch the screen to display the Home menu:

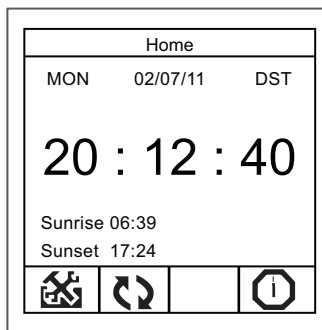

The Home screen always displays the current day of the week, date, Daylight Savings Time (DST) status and the time of day in 24 hour format. The sunrise and sunset times are also displayed based on the astronomic location settings in the panel. From most other screens you can return to the home screen by touching the <Home> icon:



From the Home screen you can rotate through the status screens and back to Home by touching the <Rotate> icon:



Enter the setup mode by touching the <Setup> icon:



Relays Override

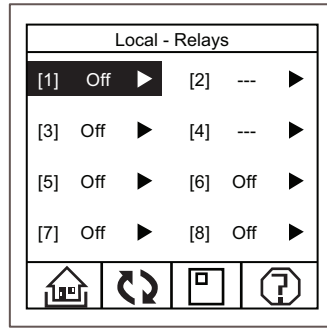
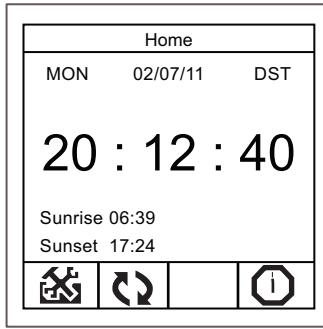

Touch Rotate  to display the Local-Relays screen

Touch a Relay to toggle the relay ON and OFF

Note that two pole relays will be controlled by the odd number, or first, relay position. The even number position will be blank. For example, a two pole relay module installed in position #1 on the DIN rail will be controlled by the relay #1 display. Relay #2 will be shown as a “---” position on the screen.

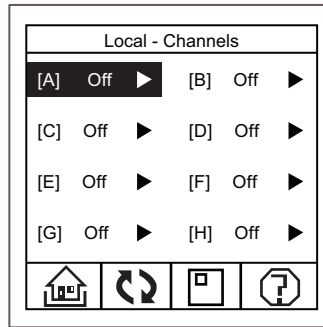

Touch Rotate  to bring up the Channels screen

There are three states of a channel depending on the states of assigned relays: ON, OFF and MIX (when there is a mixture of ON and OFF relays).

The relays that are assigned can be toggled on and off. By default, the relays are assigned to the channels on a one-to-one basis. That is, relay one to channel A, relay 2 to channel B, etc. See the section on Assign Relays/Channel under Setup to change the default assignment of relays to the channels. If channels are not assigned, a “---” will display.

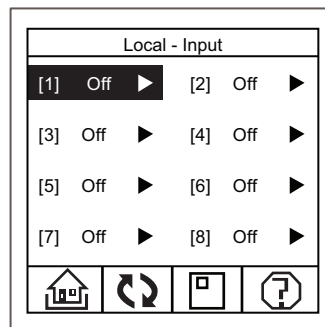
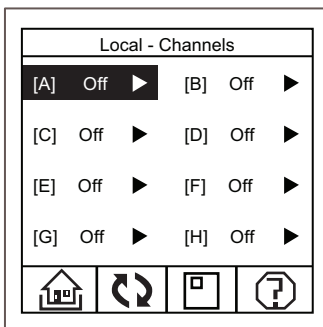

Touch Rotate  to bring up the Inputs screen

Touch the input number to toggle the relay(s) programmed to the input on and off

Setup Menus

There are three setup menus that you can cycle through:

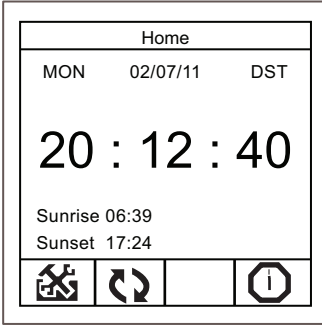

Select Setup  from Home menu for Setup menu

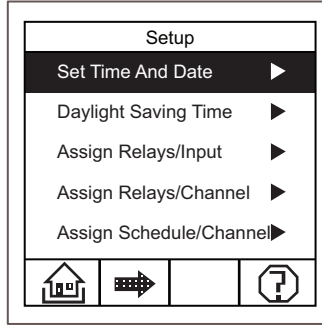

Select Next 

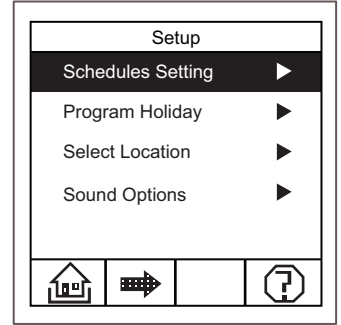

Second Setup menu displays

Select Next 

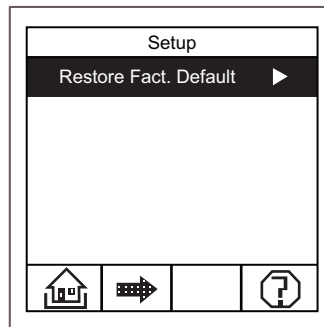

Third Setup menu displays

Setting Time and Date

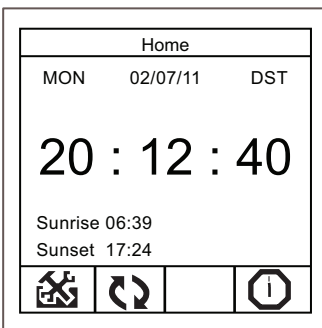

Select Setup  from the Home menu

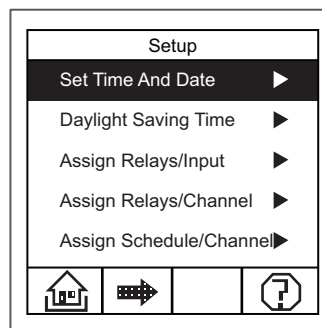

The setup menu displays

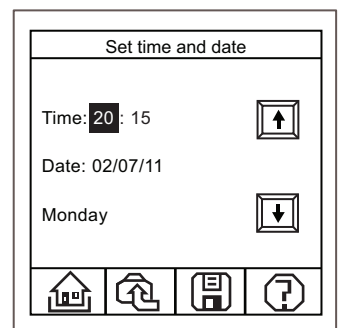

Touch the value to change. Use up and down arrows to change value. Select



Daylight Saving Time

The LC8 can be set to follow or not follow DST.

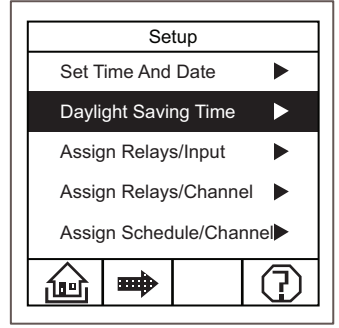
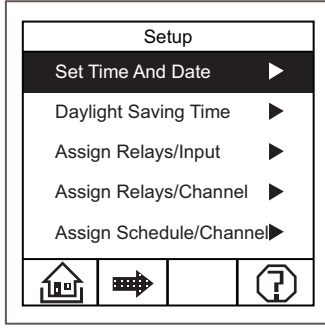
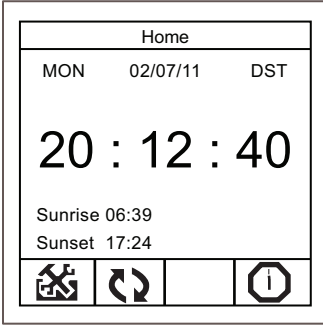

Select Setup  from the Home menu

The Setup menu displays

Select Daylight Saving Time
Touch again to display DST screen

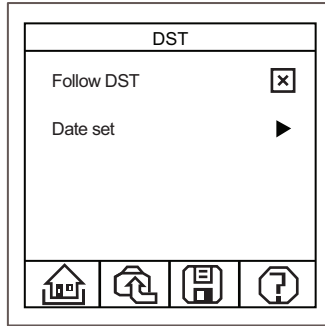

Touch the check box to activate or deactivate DST feature. Select



Save

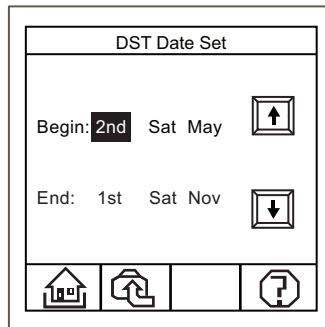
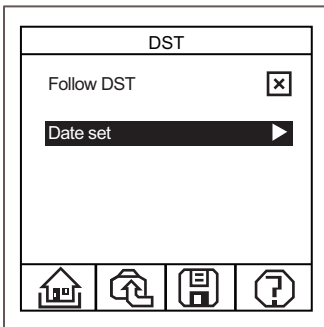

Touch Date set twice to display DST Date Set screen

Touch desired value. Use up and down arrows to change value

Assigning Relays to an Input

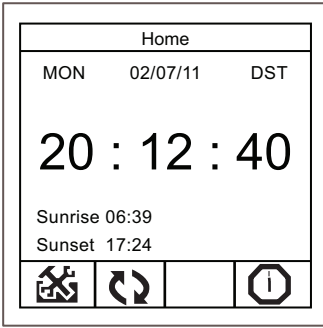

Select Setup  from the Home menu

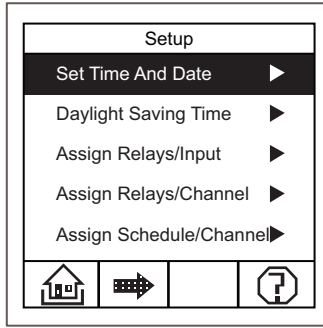

The Setup menu displays

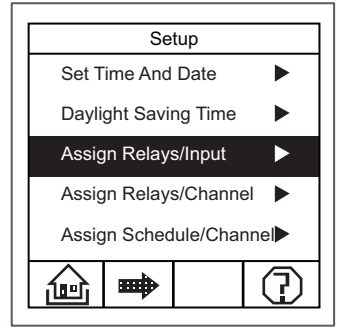

Touch Assign Relays/Input. Touch again

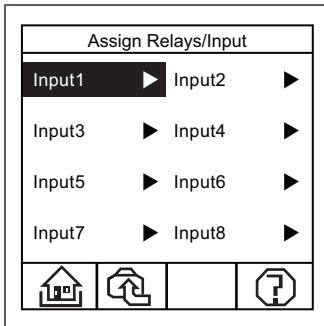

The Assign Relays/Input menu displays. Touch the input number to program.

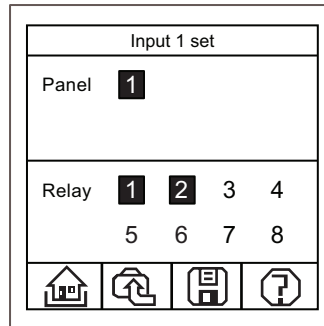

The Input number Set screen displays relays set to this input. Select Save



Assigning Relays to Channels

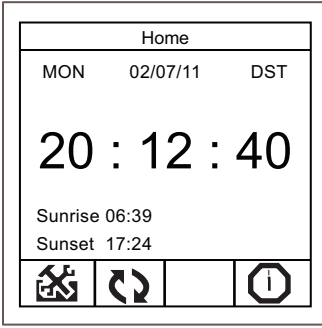

Select Setup  from the Home menu

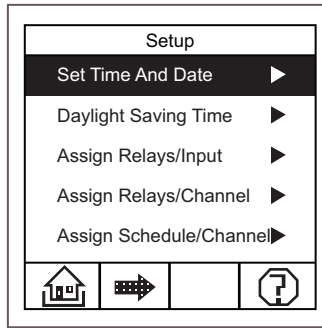

The Setup menu displays

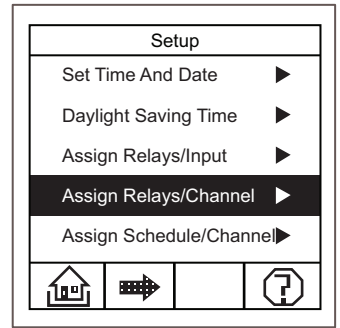

Touch Assign Relays/Channels to highlight. Touch again to enter relay assignment menu

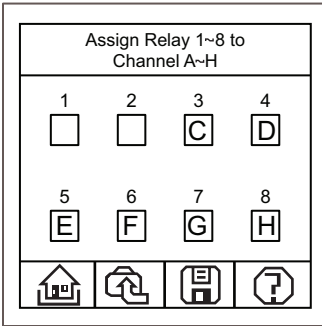

- Select relay number to highlight
- Touch relay number again to select Channel A
- Repeat above for all desired relays

- Select Save 

Note: If dashes [--] and not boxes are shown in your relay assignment menu, you have an SPST installed instead of a DPST:

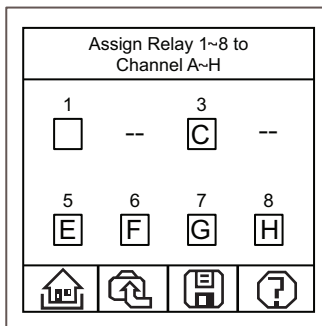

Assigning Schedules to Channels

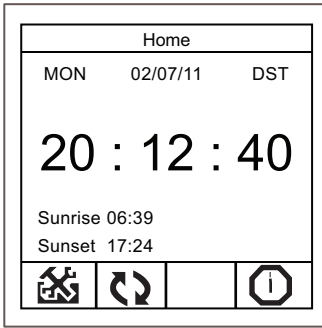

Select Setup  from the Home menu

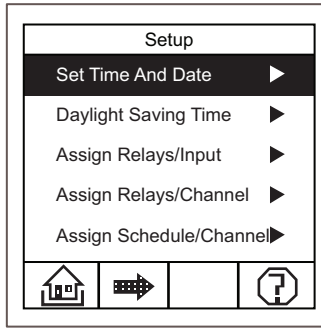

The Setup menu displays

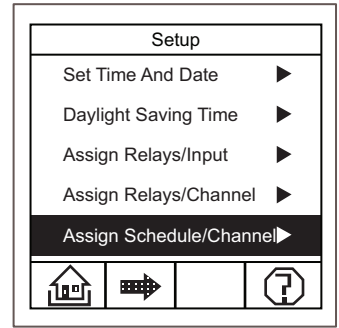

Touch Assign Schedule/Channel. Touch again

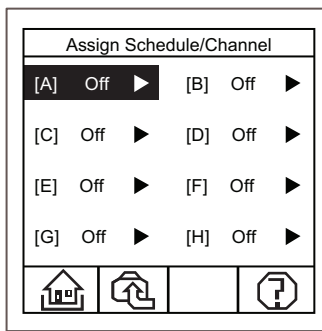

The Assign Schedule/Channel menu displays. Select Channel A

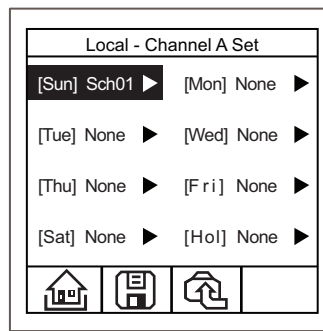

Enter Sch01 to each day of the week desired. Select

Save 

Schedules

Schedule ON/OFF

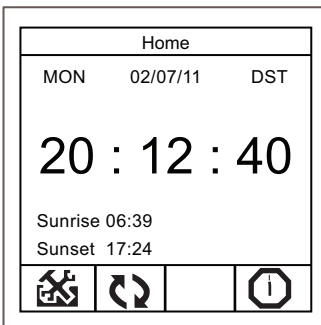

Select Setup  from the Home menu

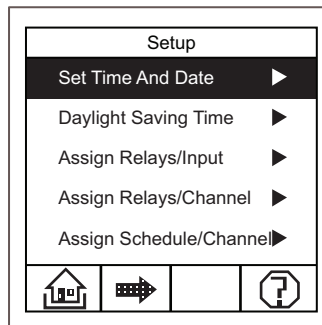

Select Next 

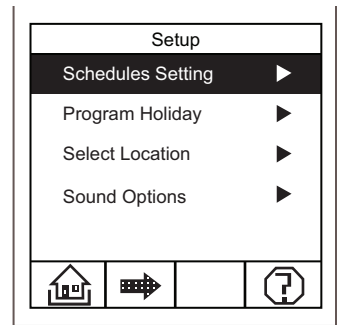

Touch Schedules Setting to display Schedule # setup menu

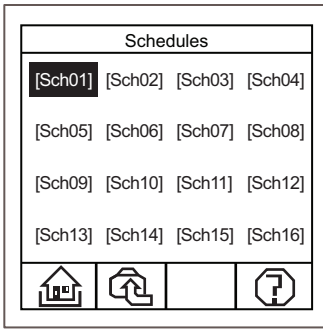

Select (Sch01). Touch again

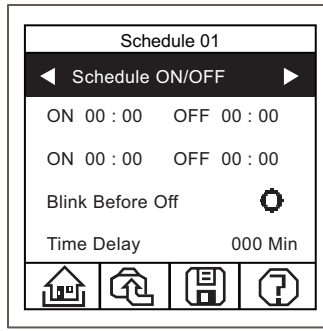

Select schedule type by touching arrows and cycling through the choices

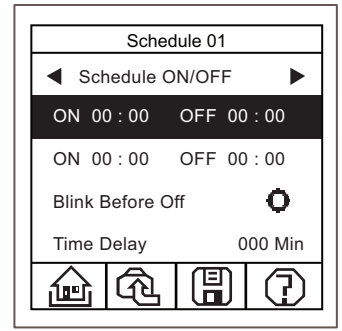

Touch ON/OFF to display Schedule Time menu

If the Blink Before Off feature is to be active for this schedule:

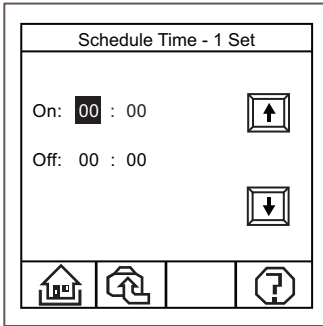

Use up and down arrows to select times.

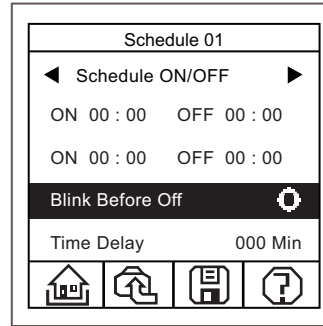

Touch the Blink Before Off display

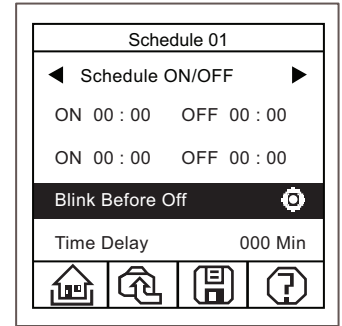

Then touch the circle display. A dot indicates the blink feature is active. No dot indicates that the blink feature is not used for this schedule.

If a wall switch will be used with the lighting controlled by this schedule, you will need to set a Time Delay for the switch.

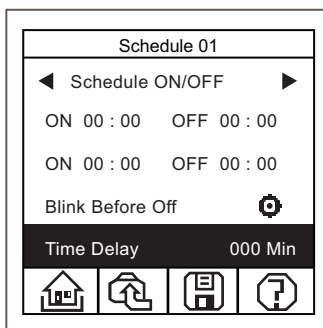

Touch time delay to display Time Delay screen

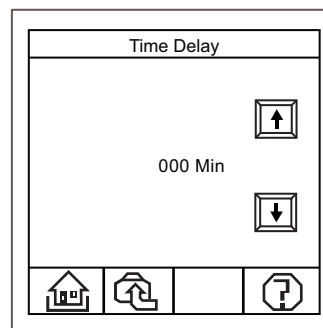

Use up and down arrows to set number of minutes between OFF sweeps

Manual ON/Schedule OFF

Time settings will turn the lighting OFF. Lighting will be turned ON manually. This setting works similar to Schedule ON/OFF, except that the ON time setting does not turn the lighting ON. It determines the time when the Time Delay feature is deactivated.

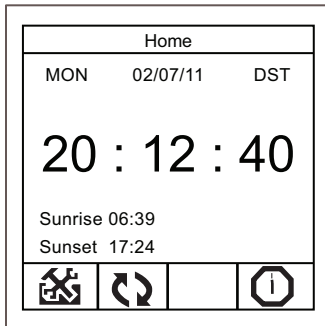

Select Setup  from the Home menu

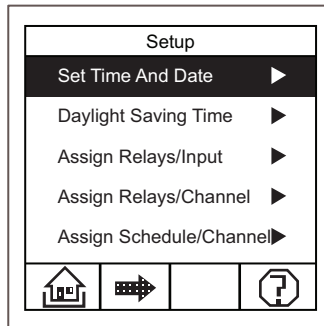

Select Next 

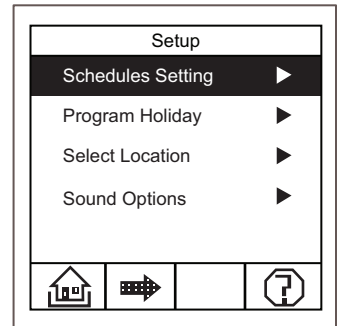

Touch Schedules Setting to display Schedule # setup menu

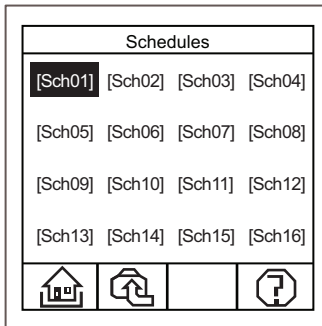

Select [Sch01]. Touch again

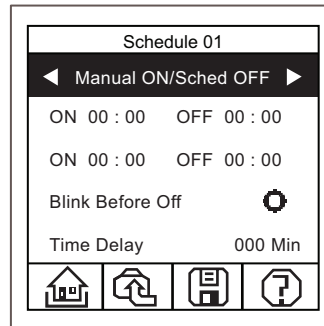

Select schedule type by touching arrows and cycling through the choices

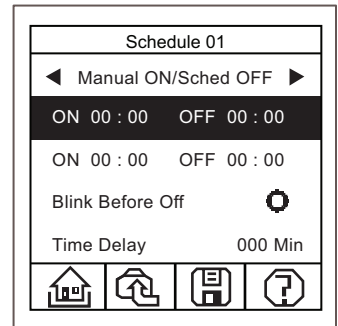

Touch ON/OFF to display Schedule Time menu

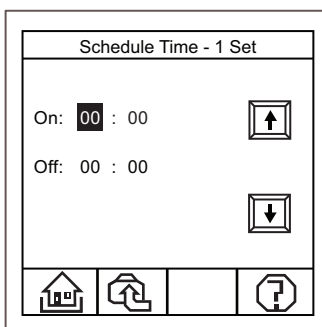

Use up and down arrows to select times.

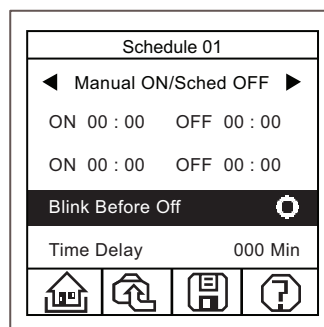

Touch the Blink Before Off display

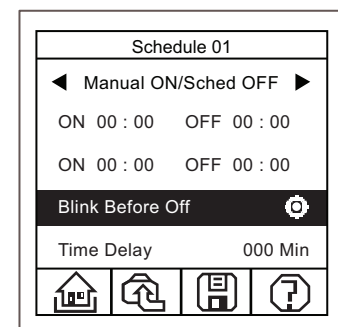

Then touch the circle display. A dot indicates the blink feature is active. No dot indicates that the blink feature is not used for this schedule.

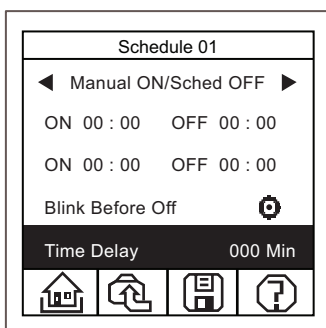

Touch time delay to display Time Delay screen

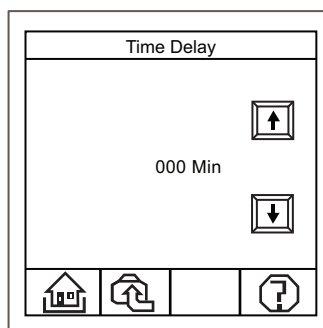

Use up and down arrows to set number of minutes between OFF sweeps

Astronomic & Schedule ON/OFF

The astronomic feature and schedule work together by issuing commands for the lighting to turn ON and OFF. The astronomic command happens only at sunset and sunrise. The schedule command happens at the set ON and OFF times for the schedule. The lighting obeys the last command it is given.

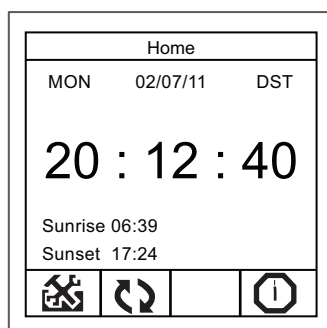

Select Setup  from the Home menu

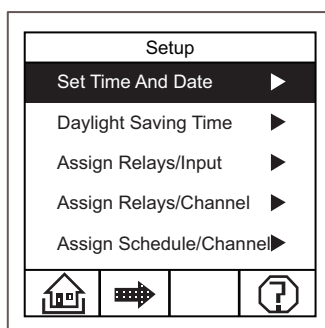

Select Next 

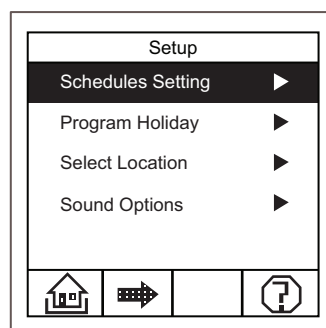

Touch Schedules Setting to display Schedule # setup menu

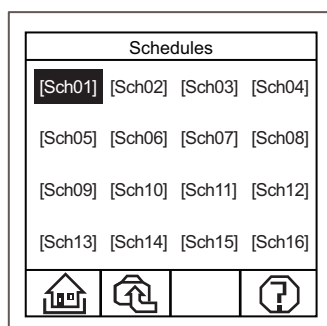

Select [Sch01]. Touch again

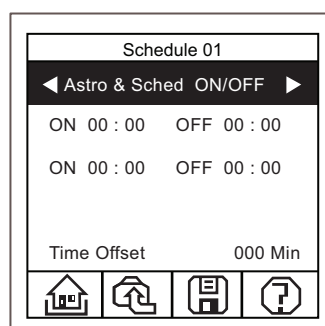

Select schedule type by touching arrows and cycling through the choices

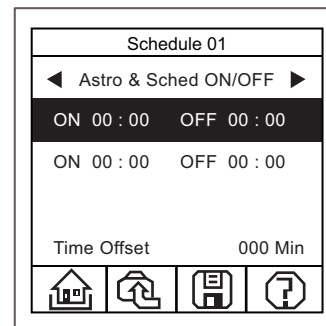

Touch ON/OFF to display Schedule Time menu

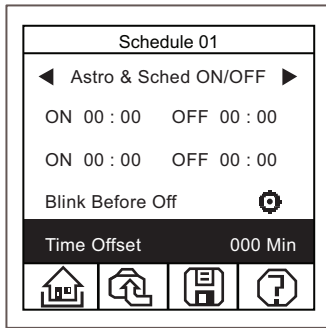

Touch Time Offset. Touch again to set sunrise or sunset offset.

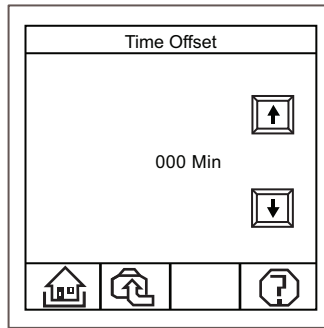

Use up and down arrows to set number of minutes for Time Offset

Photocell & Schedule ON/OFF

The photocell and schedule work together by issuing commands for the lighting to turn ON and OFF. The photocell command happens only on a transition from light-to-dark or dark-to-light. The schedule command happens at the set ON and OFF times for the schedule. The lighting obeys the last command it is given.

Note: If the photocell only is to turn the light ON and OFF, use this selection but do not enter schedule times for ON and OFF. If the Astronomic feature only is to turn the lighting ON and OFF, use this selection but do not enter schedule times for ON and OFF.

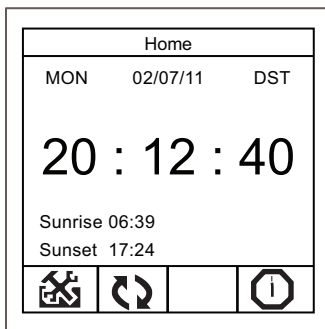

Select Setup  from the Home menu

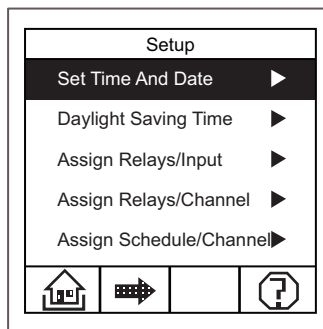

Select Next 

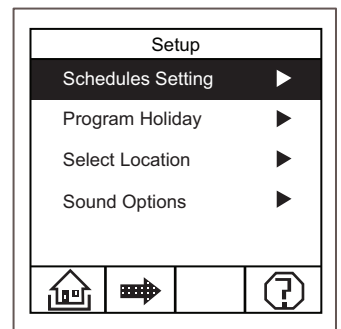

Touch Schedules Setting to display Schedule # setup menu

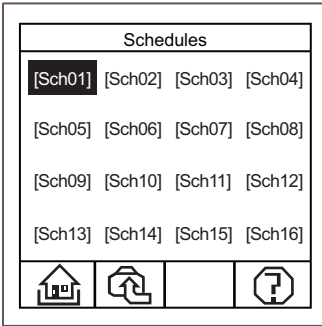

Select [Sch01]. Touch again

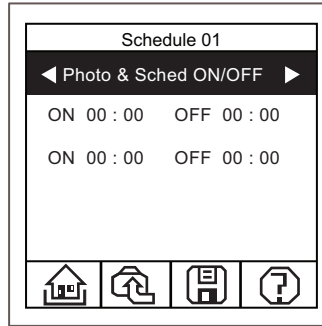

Select schedule type by touching arrows and cycling through the choices

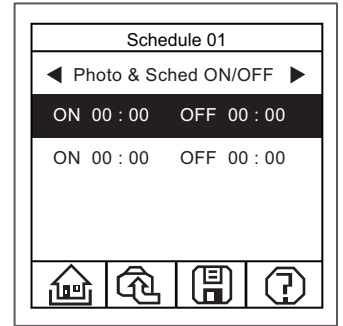

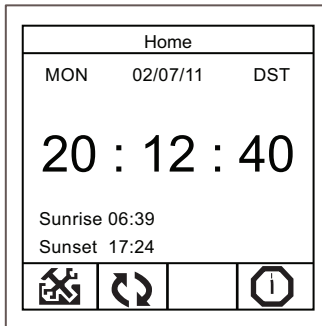

Touch ON/OFF to display Schedule Time menu

AS-100 Auto ON/OFF – This setting will use the Auto ON/OFF feature of the AS-100 Automatic Wall Switch (see the AS-100 installation instructions for more information).

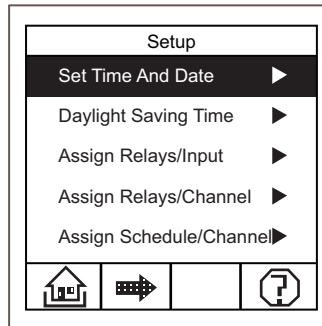

Select Setup  from the Home menu



Select Next 

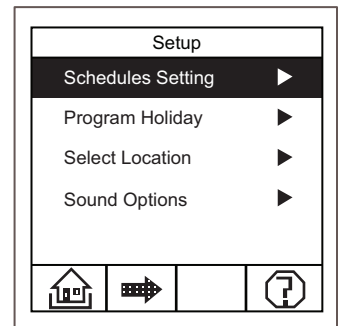

Touch Schedules Setting to display Schedule # setup menu

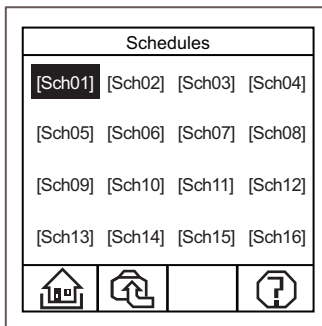

Select [Sch01]. Touch again

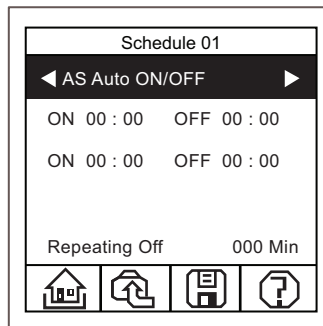

Select schedule type by touching arrows and cycling through the choices

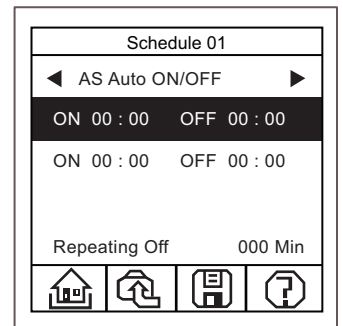

Touch ON/OFF to display Schedule Time menu

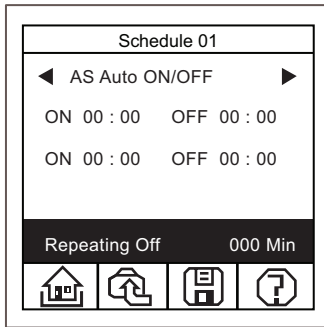

Touch Repeating Off twice to enter Time Repeat screen

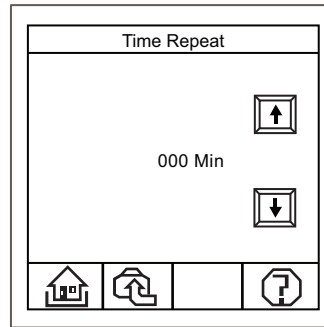

Use up and down arrows to set number of minutes between OFF sweeps during the scheduled off periods

AS-100 Manual ON/Auto OFF – This setting will use the Manual ON/Automatic OFF feature of the AS-100 Automatic Wall Switch (see the AS-100 installation instructions for more information). Follow the screens for AS-100 Auto ON/OFF, selecting AS Manual ON/Auto OFF when selecting schedule type.

Note: The AS-100 switch must remain powered at all times in order to operate

- Do not assign an input switch to a relay controlling the AS-100
- Avoid assigning relay/s controlling the AS-100 to schedules other than those designed for the AS-100 (AS Auto ON/OFF and AS Manual ON/Auto OFF)
- Avoid grouping the relay controlling the AS-100 with other relays (unless relay controls another AS-100)
- When turning the relays ON/OFF from the user interface, avoid the relay/s controlling the AS-100

Schedule Day Spanning

For a scheduled event to span midnight it is necessary to create a schedule event in both days where the beginning of the event starts on day one and ends at midnight 00:00 and another event continues on day 2 beginning at midnight 00:00. When set up this way, the schedule event will pass through midnight without effecting the lighting. No ON or OFF event will actually occur at midnight (00:00).

Setting Up a Holiday Schedule

The schedule assigned as the Holiday Schedule is special in that it will automatically be substituted for the regular daily schedule on each of a user entered list of calendar dates.

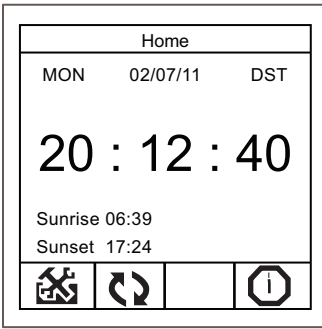

Select Setup  from
from Home menu

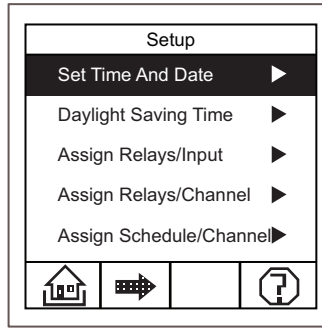

Select Next 

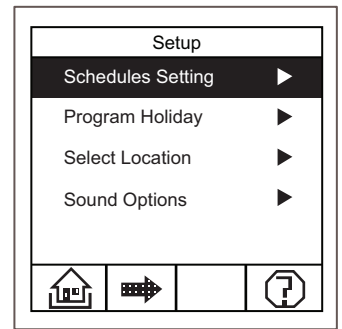

Schedules Setting displays

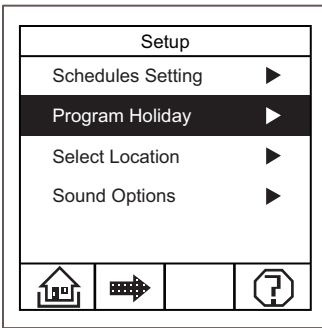

Touch Program Holiday.
Touch again

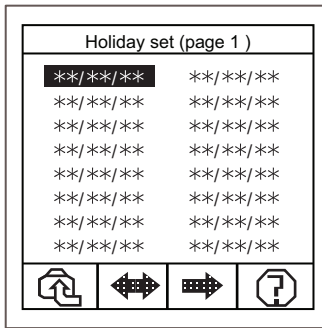

Touch a ****/**/**** to display
Holiday Date Set

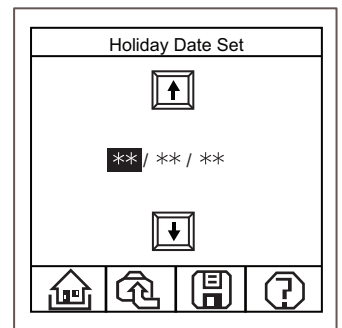

Use the up and down arrows
to set month, day and year.

Select Save 

To set Holiday Date Range:

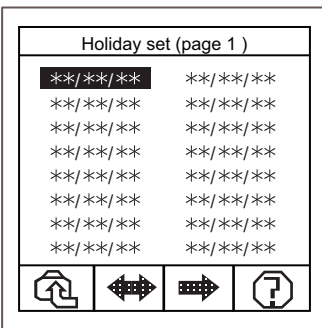

Select Range 

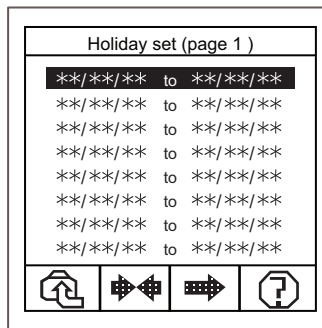

Touch a ****/**/**** to display
the Holiday Date Set screen

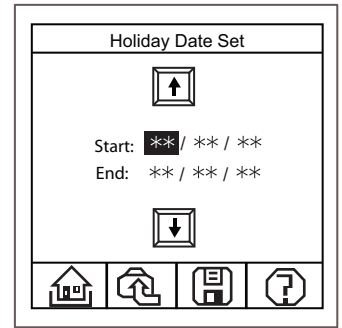

Use the up and down arrows
to set start and end dates.

Select Save 

Setting a Location for the Astronomic Feature

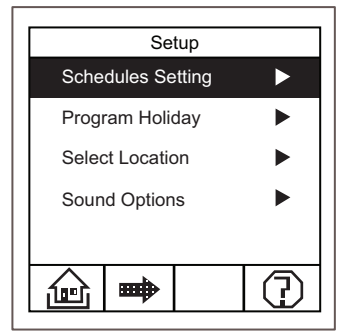
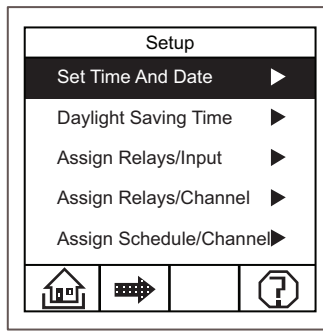
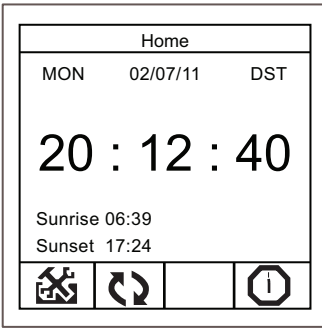

Select Setup  from

Select Next 

Schedules Setting displays

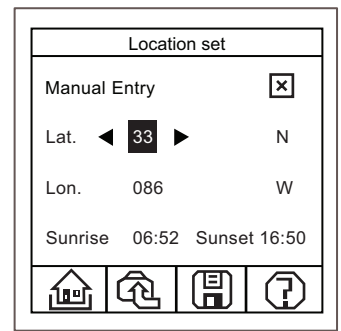
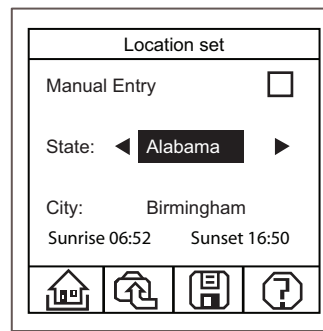
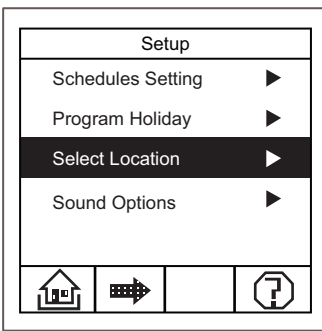

Touch Select Location.
Touch again

Scroll to select state
Scroll to select city

Touch Manual Entry to display manual Location Set screen. Set Lat and Lon

Select Save 

Sound Options

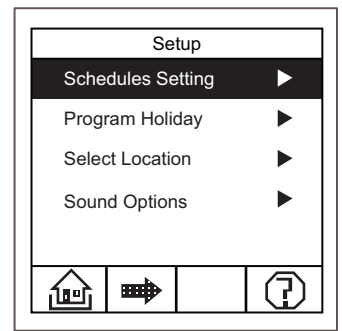
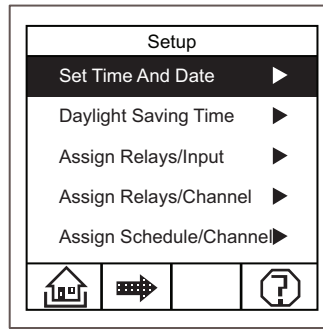
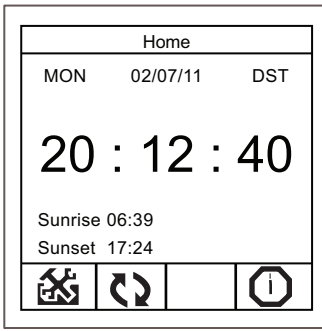

Select Setup  from the Home menu

Select Next 

Schedules Setting displays

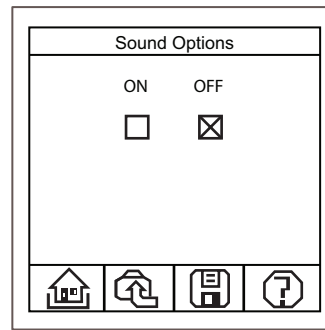
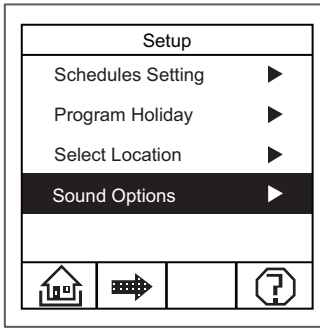

Touch Sound Options.
Touch again

Touch the box to turn sound ON
or OFF when screen is touched

Returning the LC8 Panel to Factory Default Settings

To erase all programming and return the panel to factory default configuration:

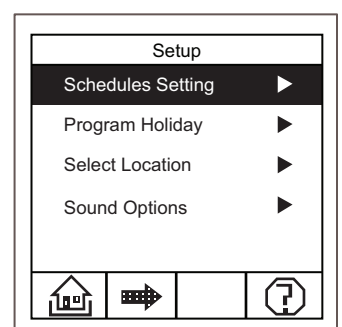
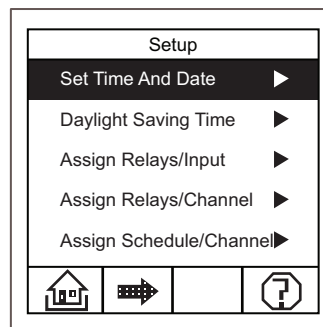
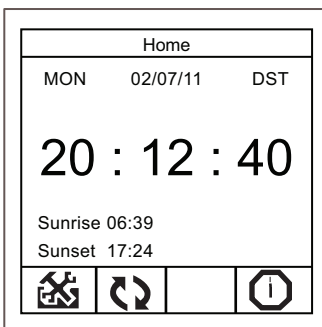

Select Setup  from the Home menu

Select Next 

Select Next 

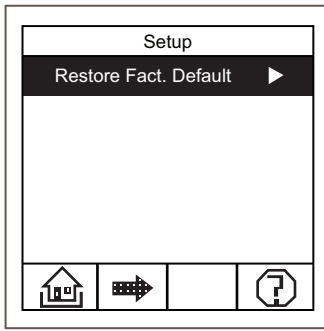

Touch Restore Fact. Default

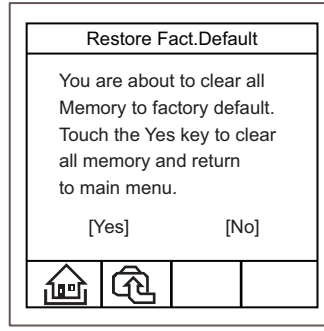

Confirm the action by touching Yes. To cancel the action and return to the menu, touch No

TROUBLESHOOTING

Problem	What to Check	What to do
The LCD screen is blank	Check that the unit has power, three red LEDs illuminated on the main board	LEDs not lit, check for input power, check circuit breaker. LEDs are lit, replace main board
The touch screen does not control relays	Check that the relay modules are installed per the instructions, check that the connectors between the relay module(s) are firmly seated together	Properly install relay modules, firmly seat the connectors
Schedule controls lights at the wrong time	Check that the time zone is correctly set. Check that the date and time are set correctly	Set the proper time zone Set the proper date and time
Photocell turns lights OFF too early	Check the aperture setting on the photocell	Increase the aperture size on the photocell
Photocell turns lights OFF too late	Check the aperture setting on the photocell	Decrease the aperture size on the photocell
Switch does not control the lights	Does the corresponding touch screen INPUT override control the lights?	Check the wiring of the switch, replace switch. Check that the input# is programmed to control at least one relay

For further assistance, call Technical Support at 800.879.8585.

Lighting Control Panel Circuit & Program Documentation Form

Switch Input	Controlled Relays or Controlled Channel	Relay Pole	Load Description	Assigned Channel
1		1		
2		2		
3		3		
4		4		
5		5		
6		6		
7		7		
8		8		

Channel Letters below left correspond to Channel letters above right

Channel	Mon	Tue	Wed	Thu	Fri	Sat	Sun
A							
B							
C							
D							
E							
F							
G							
H							

Enter the schedule numbers that apply in the spaces above

WARRANTY INFORMATION

WattStopper warrants its products to be free of defects in materials and workmanship for a period of five (5) years. There are no obligations or liabilities on the part of WattStopper for consequential damages arising out of, or in connection with, the use or performance of this product or other indirect damages with respect to loss of property, revenue or profit, or cost of removal, installation or reinstallation.

WattStopper[®]

2800 De La Cruz Blvd Santa Clara, CA 95050
 www.wattstopper.com 800.879.8585

17217r2 1/2013